



---

# ADJUSTABLE TURNBUCKLES

## INSTRUCTION MANUAL

---

**The Sail Loft, Unit 16, Sandford Lane Industrial Estate, Wareham, Dorset BH20 4DY**

Phone: +44 (0)1929 554308  
[www.shade-solutions.com](http://www.shade-solutions.com)



Email: [info@kempsails.com](mailto:info@kempsails.com)  
[www.kempsails.com](http://www.kempsails.com)



## CONTENTS

<b>TURNBUCKLES</b>	<b>PG. 3</b>
M8 STANDARD	PG. 3
M8 SHORT	PG. 3
M10 STANDARD	PG. 4
M6 STANDARD	PG. 4
SINGLE END TURNBUCKLE	PG. 5
<b>FITTING INSTRUCTIONS</b>	<b>PG. 6</b>
DOUBLE ENDED TURNBUCKLE	PG. 6
SINGLE ENDED TURNBUCKLE	PG. 7

To successfully fit your Shade sail you may need additional attachments, to bridge the gap between your fixing and chosen anchorage point. A correctly tensioned Shade Sail is the key to its longevity, so when choosing hardware it is important take the specifics of each product into consideration.

Below are a series of products that can improve the fit of your Shade Sail these are all available to be purchased online:



### LONG D SHACKLE

KSFX7060 // approx. 50mm ALLOWANCE

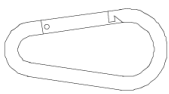

### CARBINE HOOK

KSFX9060 // 6mm x 60mm External Dimensions



### LONG LINK CHAIN

KSFX35LL // 5mm Diameter, sold by the metre



### WIRE STROP

KSFXE010 // KSFE020 // KSFXE030, manufactured to specification

0 - 1M // 1 - 2M // 2 - 3M



## TURNBUCKLES

Each end are threaded in opposite directions so that when you rotate the body of the turnbuckle one way tension will be increased, rotate the other way and tension will be released. A versatile fixing which allows for adjustments in precise increments, there is a large variety of turnbuckles that have fork - fork attachments.

### M8 STANDARD

KSFX81CB

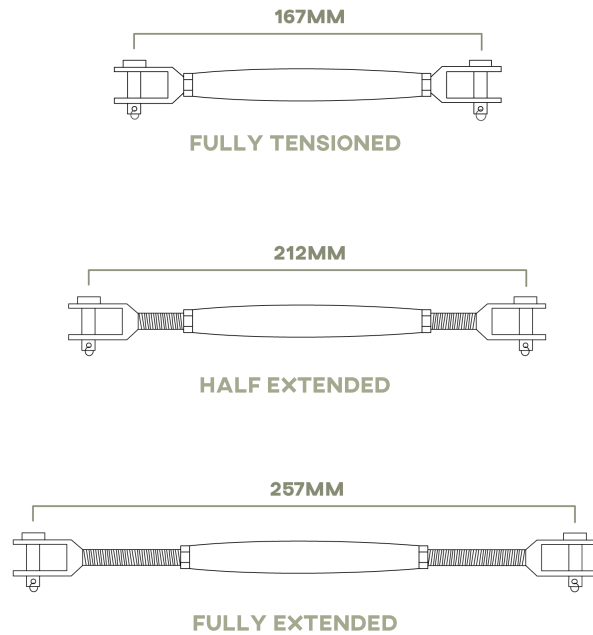
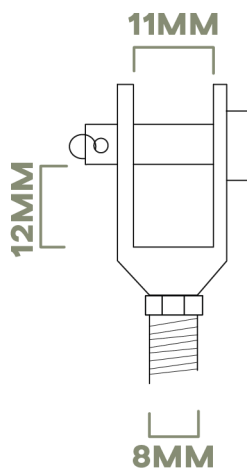

### M8 SHORT

KSFX81SH

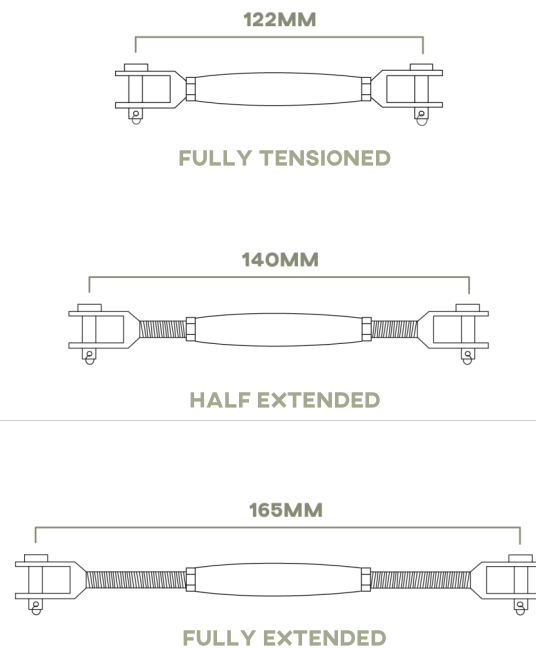
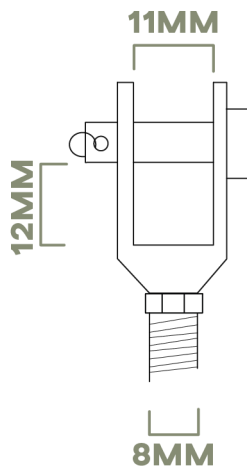



## TURNBUCKLES

### M10 STANDARD

KSFX01CB

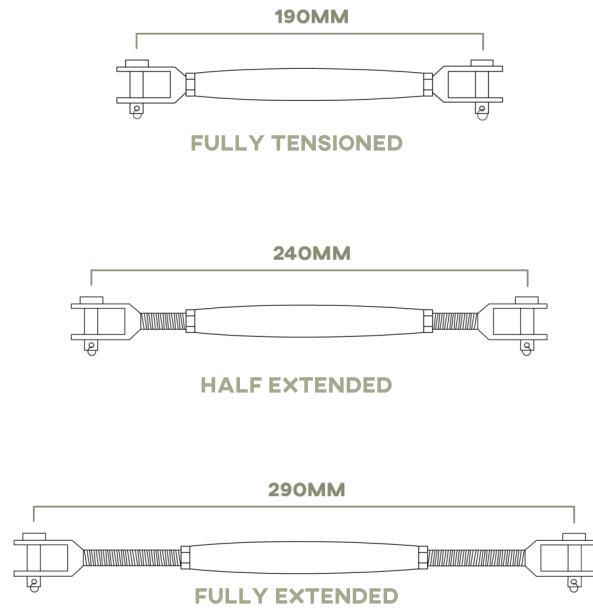
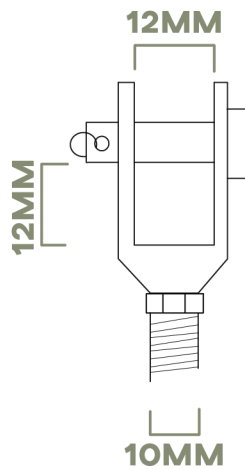

### M6 STANDARD

KSFX61CB

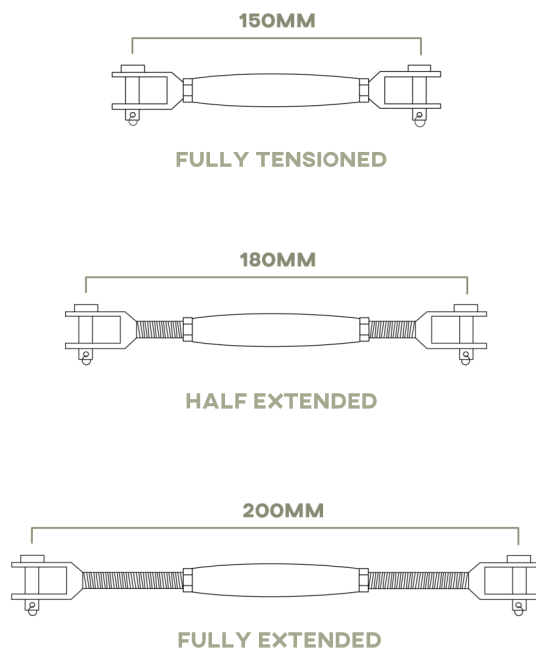
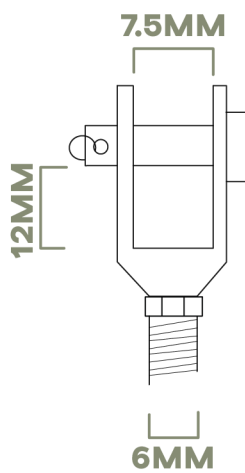



## SINGLE END TURNBUCKLES

### M8 STANDARD

KSFX8PBT

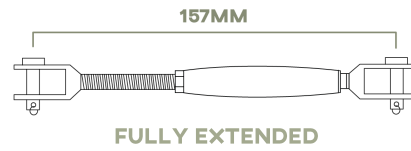
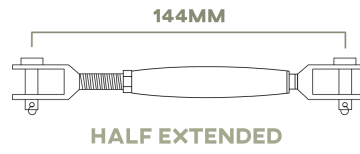
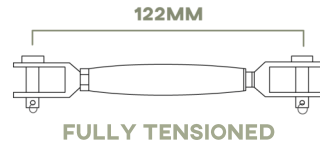
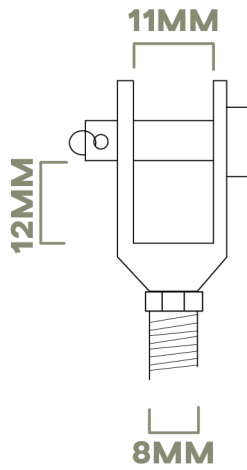

# SINGLE END FORK TURNBUCKLE



Each end is threaded in opposite directions so that when you rotate the body of the turnbuckle one way tension will be increased, rotate the other way and tension will be released. A versatile fixing which allows for adjustments in precise increments, there is a large variety of turnbuckles that have fork - fork attachments.

We only offer single end turnbuckles with an M8 screw (8mm), a wider range of dual end turnbuckles are available:

M8 Adjustable Turnbuckle

M8 Adjustable Turnbuckle (Short)

M10 Adjustable Turnbuckle

M6 Adjustable Turnbuckle

## HOW TO FIT

HANDHELD PLIERS

SCREW DRIVER



Some rules of thumb with turnbuckles are:

1. Make sure they are all evenly tensioned, if one is over tension and one under tensioned it will stretch the Shade.
2. Secure the Turnbuckle in place once tensioned correctly using the bolts, this will reduce slipping
3. Check the Turnbuckles once every couple of weeks.

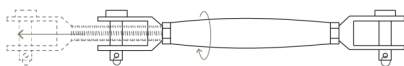

- 1 -

*Unwind Turnbuckle, apply lubrication to the thread such as lanolin - this will stop the thread from seizing up*

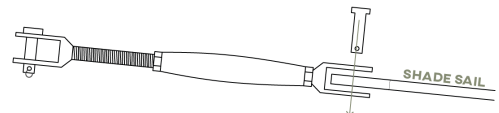

- 2 -

*Attach Shade Sail to fork connection at the fixed end of the Turnbuckle*

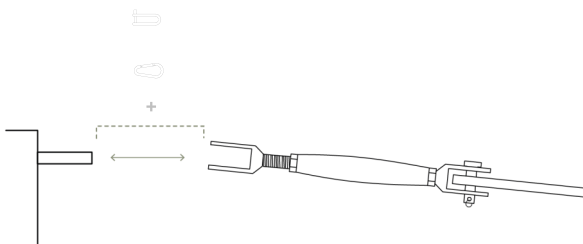

- 3 -

*Bridge any gap between Turnbuckle and anchor points with non-adjustable fixings*

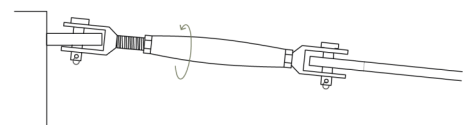

- 4 -

*Slowly tighten Turnbuckles, working around the Shade Sail. Continue until taught.*

*Secure in place by tightening nuts against central barrel*

# FORK - FORK TURNBUCKLE



This is a turnbuckle with an adjustable thread at only one end of the barrel. It is a versatile fixing which allows for adjustments in precise increments, there is a large variety of turnbuckles that have fork - fork attachments.

We offer these Turnbuckles in numerous sizes and strengths:

M8 Adjustable Turnbuckle

M8 Adjustable Turnbuckle (Short)

M10 Adjustable Turnbuckle

M6 Adjustable Turnbuckle

## HOW TO FIT

HANDHELD PLIERS

SCREW DRIVER



Some rules of thumb with turnbuckles are:

1. Make sure they are all evenly tensioned, if one is over tension and one under tensioned it will stretch the Shade.
2. Secure the Turnbuckle in place once tensioned correctly using the bolts, this will reduce slipping
3. Check the Turnbuckles once every couple of weeks.

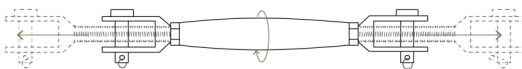

- 1 -

*Unwind Turnbuckle, apply lubrication to the thread such as lanolin - this will stop the thread from seizing up.*

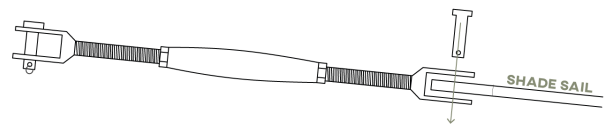

- 2 -

*Attach Shade Sail to fork connection at the fixed end of the Turnbuckle*

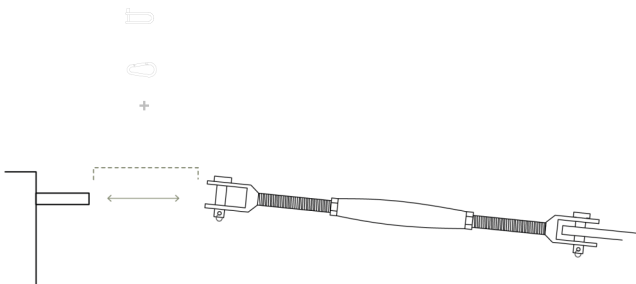

- 3 -

*Bridge any gap between Turnbuckle and anchor points with non-adjustable fixings*

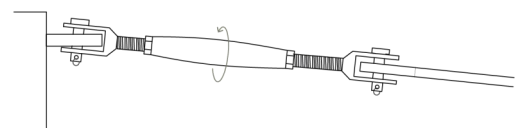

- 4 -

*Slowly tighten Turnbuckles, working around the Shade Sail. Continue until taut.*

*Secure in place by tightening nuts against central barrel*