



---

# **ADJUSTABLE TURNBUCKLES**

## **INSTRUCTION MANUAL**

---

**The Sail Loft, Unit 16, Sandford Lane Industrial Estate, Wareham, Dorset BH20 4DY**

Phone: +44 (0)1929 554308  
[www.shade-solutions.com](http://www.shade-solutions.com)



Email: [info@kempsails.com](mailto:info@kempsails.com)  
[www.kempsails.com](http://www.kempsails.com)



# CONTENTS

<b>TURNBUCKLES</b>	<b>PG. 3</b>
M8 STANDARD	PG. 3
M8 SHORT	PG. 3
M10	PG. 4
M6	PG. 4
SINGLE END TURNBUCKLE	PG. 5
<b>FITTING INSTRUCTIONS</b>	<b>PG. 5</b>
(RELATIVE TO ALL TURNBUCKLES)	

To successfully fit your Shade sail you may need additional fixed linkages to bridge the gap between your fixing and chosen anchorage point. A correctly tensioned Shade Sail is the key to its longevity, so when choosing hardware it is important take the specifics of each product into consideration.

Below are examples of extra fixings available which can be used in addition to the tensioning fixings; all can be purchased online:



**LONG D SHACKLE**

KSFX7060 // approx. 50mm ALLOWANCE

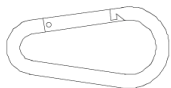

**CARBINE HOOK**

KSFX9060 // 6mm x 60mm External Dimensions



**LONG LINK CHAIN**

KSFX35LL // 5mm Diameter, sold by the metre



**WIRE STROP**

KSFXE010 // KSFE020 // KSFXE030, manufactured to specification

0 - 1M // 1 - 2M // 2 - 3M





# TURNBUCKLES

Each end are threaded in opposite directions so that when you rotate the body of the turnbuckle one way tension will be increased, rotate the other way and tension will be released. A versatile fixing which allows for adjustments in precise increments, there is a large variety of turnbuckles that have fork - fork attachments.

## M8 STANDARD

KSFX81CB

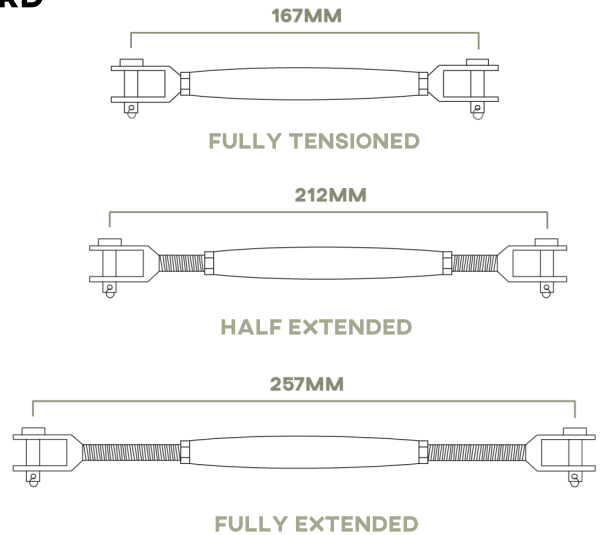
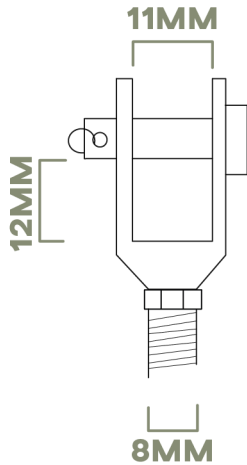

## M8 SHORT

KSFX81SH

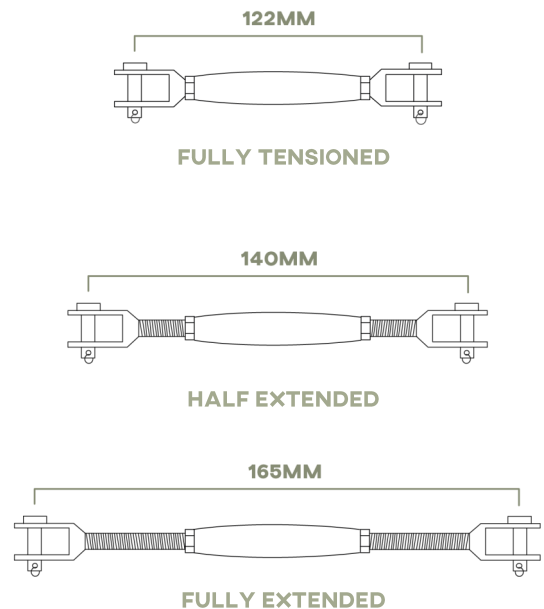
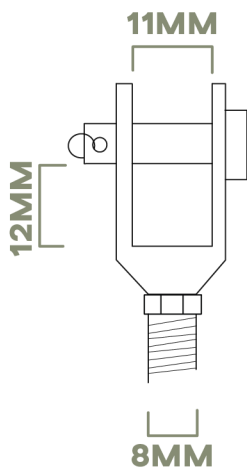



# TURNBUCKLES

## M10 TURNBUCKLE

KSFX01CB

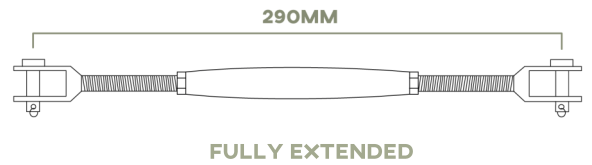
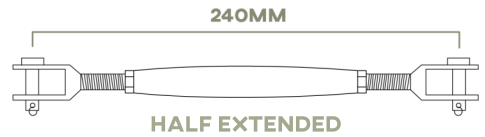
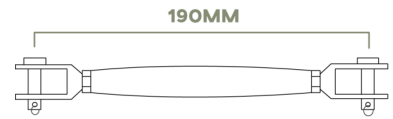
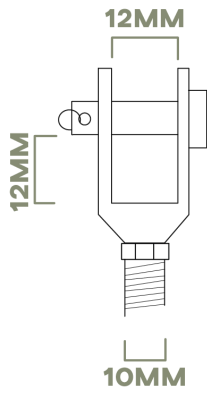

## M6 TURNBUCKLE

KSFX61CB

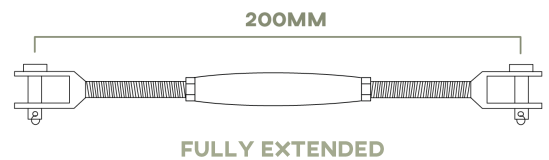
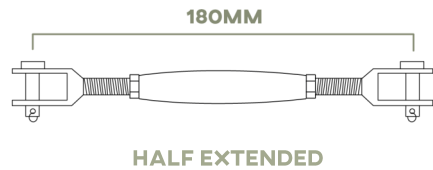
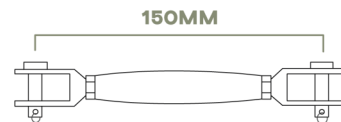
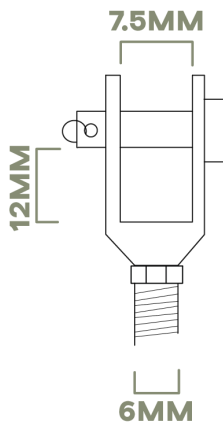



# SINGLE END TURNBUCKLES

HANDHELD PLIERS



SCREW DRIVER



## M8 SINGLE END ADJUSTABLE

KSFX8PBT

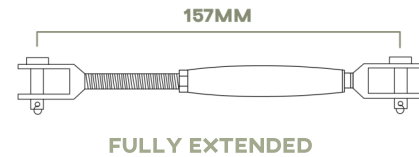
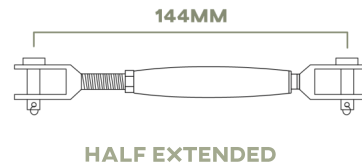
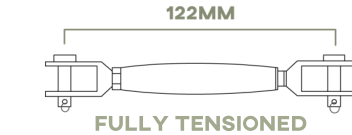
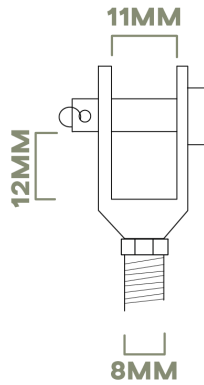

## FITTING INSTRUCTIONS

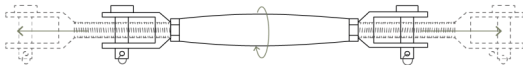

- 1 -

Unwind Turnbuckle, apply lubrication to the thread such as lanolin - this will stop the thread from seizing up.

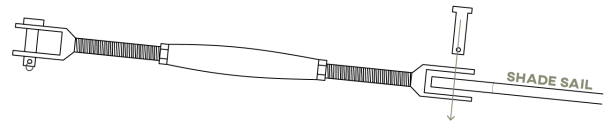

- 2 -

Attach Shade Sail to fork connection at the fixed end of the Turnbuckle

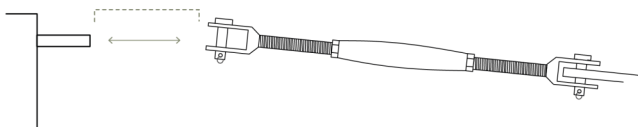

- 3 -

Bridge any gap between Turnbuckle and anchorage points with non-adjustable fixings if required.

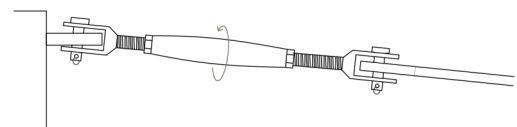

- 4 -

In turn tighten the barrel, a little at a time working around the Shade Sail until evenly tensioned all round.

Secure locking nuts against central barrel. Allow to settle in and re tension if necessary

- 5 -

The Sail Loft, Unit 16, Sandford Lane Industrial Estate, Wareham, Dorset BH20 4DY

Phone: +44 (0)1929 554308  
www.shade-solutions.com



Email: info@kempsails.com  
Www.kempsails.com